

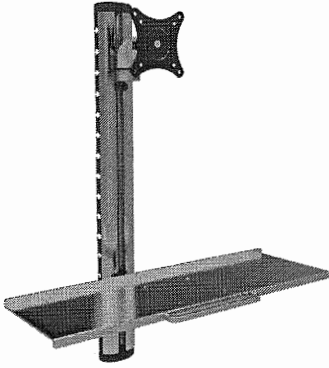

Plasma/LCD TV Stand Assembly Instruction









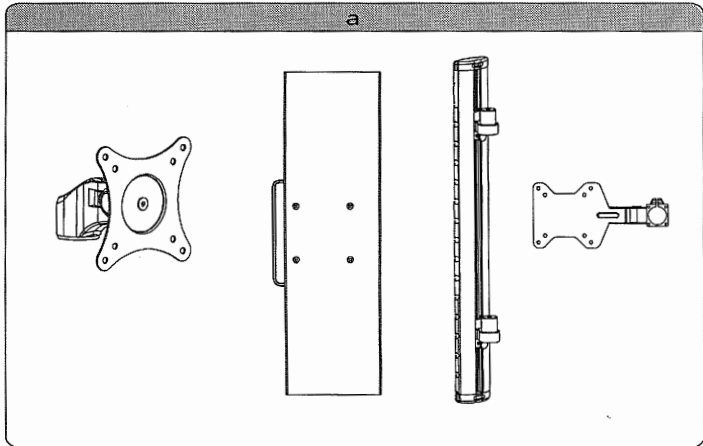



Max. VESA 75x75/100x100





 max.
8kg(18lbs)

13" - 27"(33-69cm)

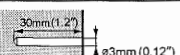

B		M4x12 (x4)		
C				M5x18 (x1) M5x10 (x4) M5 (x4)
D			M6x25 (x1) (x1)	
E				S=3mm(x1) S=4mm(x1) S=5mm(x1) (x5)
F			Ø8x40 (x3) M6x50 (x3)	

INSTALLATION

①      F

wood, wood stud wall

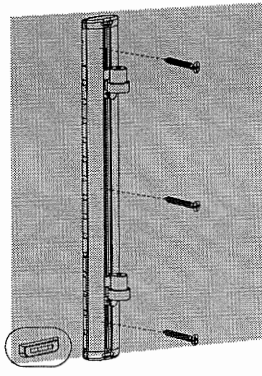

OR

②      F

concrete wall

