

VESALG Bracket Assembly Instructions

Step 1: Bracket

- a. Position the Bracket (A) at desired height on wall.
(Hardware NOT included)

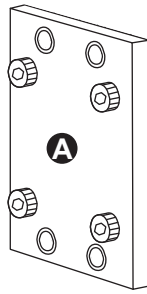

Step 2: Mounting Mid Bracket

- a. Remove the side clamp located on the left of the Bracket (A), then loosen the (4) 6mm hex bolts enough to allow the keyholes in the Mid Bracket (B) to slide over the bolts.
- b. Align the keyholes and slide the Mid Bracket (B) over and down the hex bolts. Once the Mid Bracket (B) is in position, tighten down all 4 bolts using the 6mm allenkey provided.
- c. Return the Side Clamp to its original position making sure the folded side overlaps the Mid Bracket (B). Tighten clamp locking the Mid Bracket (B) in place.

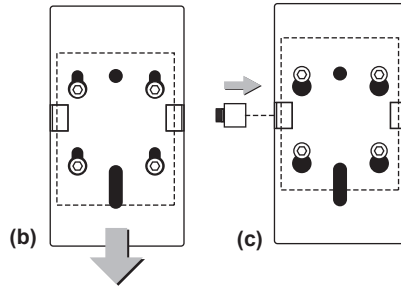
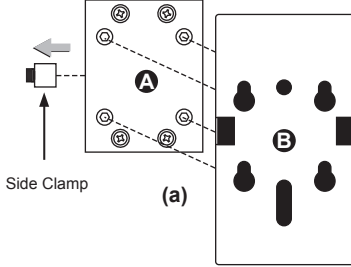

Step 3: Installing Hangers onto monitor

- a. Using provided hardware*, screw hangers (D) into mounting holes on back of display. If display allows, hangers may be installed so that the screen is in either landscape or portrait orientation. Various combinations of spacers/screws may need to be used depending on the monitor's configuration.
- b. Make sure that the corresponding holes on each hanger are used when mounting the monitor to keep the screen level.

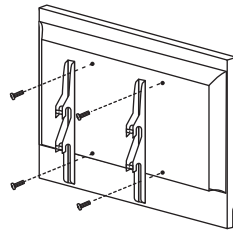

Note! The height of the screen on the display may be adjusted by using different mounting holes on the hangers.

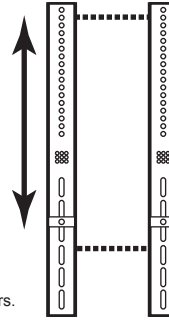

Bracket Parts

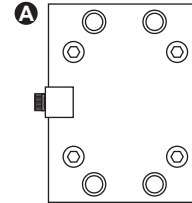

(x1) Bracket

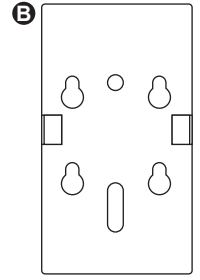

(x1) Mid Bracket

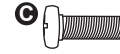

(x4) M8 Screws



(x2) Hanger

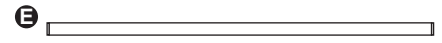

(x2) Crossbars

Included Tools

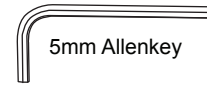

5mm Allenkey

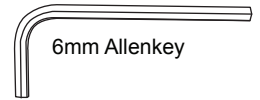

6mm Allenkey

Monitor Mounting Hardware



1/4 Inch Spacers (Nylon)
(x4)



1/8 Inch Spacers (Nylon)
(x4)



6mm Washers (Metal)
(x4)

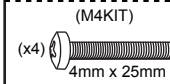

(M4KIT)
(x4) 4mm x 25mm



(M5KIT)
(x4) 5mm x 25mm

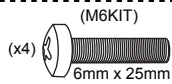

(M6KIT)
(x4) 6mm x 25mm

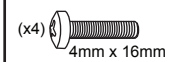

(x4) 4mm x 16mm

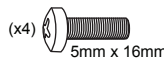

(x4) 5mm x 16mm

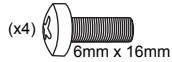

(x4) 6mm x 16mm

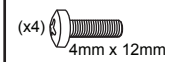

(x4) 4mm x 12mm

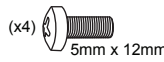

(x4) 5mm x 12mm

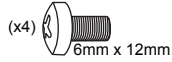

(x4) 6mm x 12mm

*The monitor mounting hardware that is included with this unit is designed to work with most standard monitors. Additional hardware may be purchased at your local hardware supplier.

Step 4: Secure Crossbars & Mount Monitor

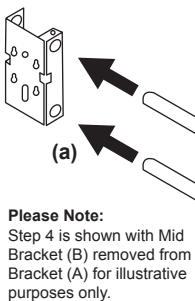

Please Note:
Step 4 is shown with Mid Bracket (B) removed from Bracket (A) for illustrative purposes only.

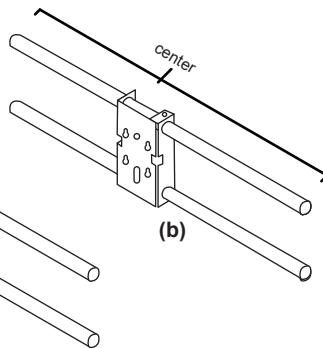

- b. Center Crossbars (E) in Mid Bracket (B).

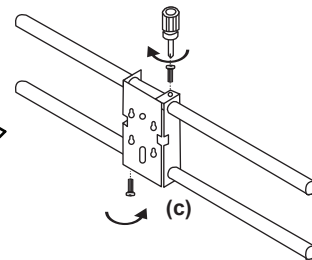

- c. Secure tightly using supplied M8 Screws (C).

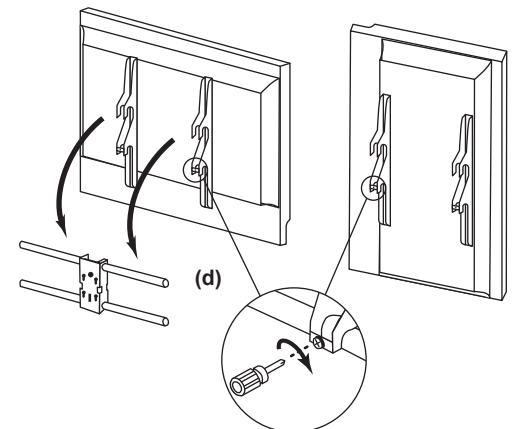

- d. Hook Hangers (D) to Crossbars (E) on back of monitor. Check that the screen is centered, then insert and tighten 8M Screws (C) on Hangers (D) to secure the monitor to the Crossbars (E).