

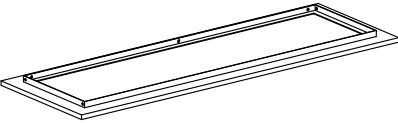

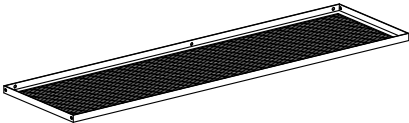

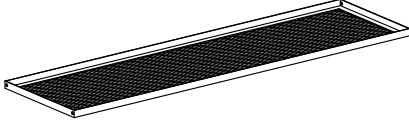

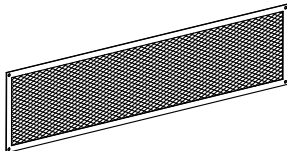
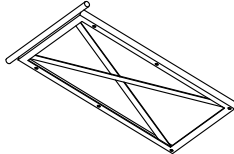
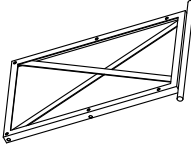
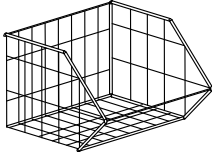
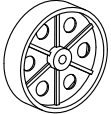

ASSEMBLY INSTRUCTIONS

SMMMRC - Metal Mesh Rolling Cart with Wood Top

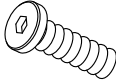
V20.04

Parts List

								
A×1PC	B×1PC	C×1PC	D×1PC	E×1PC	F×1PC			
								
G×3PCS	H×4PCS	I×18PCS	J×18PCS	K×4PCS	L×4PCS	M×1PC	N×1PC	O×1PC

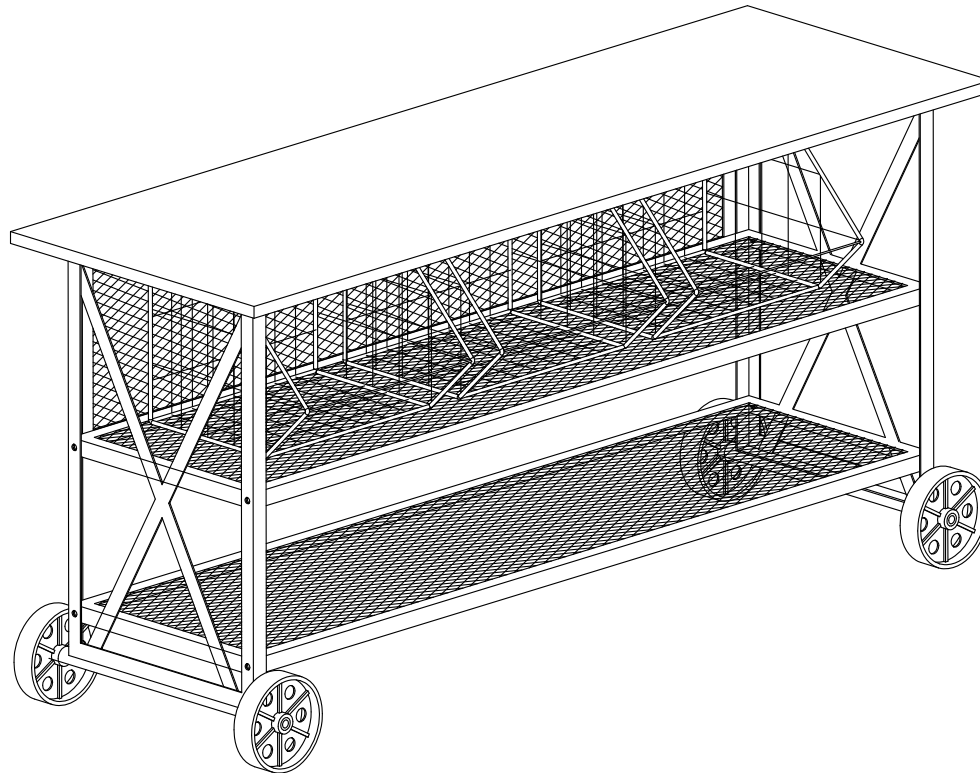

ASSEMBLY INSTRUCTIONS

SMMMRC - Metal Mesh Rolling Cart with Wood Top

V20.04

Step 1. Attach Side Panel (E & F) to Countertop (A) with Screw (I) and Cap (J). Hand tighten first then use Hex Key (M) and Wrench (O) to secure them. Assemble the Middle Shelf (B) and Bottom Shelf (C) the same way. Then attach the Back Panel (D) to the assembled cart.

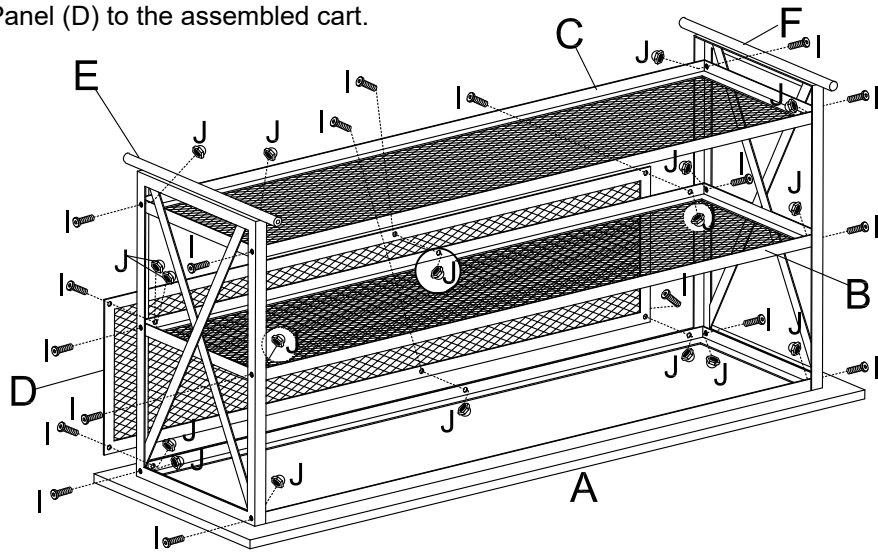

Step 2. Attach 4 Wheels (H) to bottom of the cart with Screw (L) and Washer (K). Use enclosed Hex Key (N) to secure the wheels.

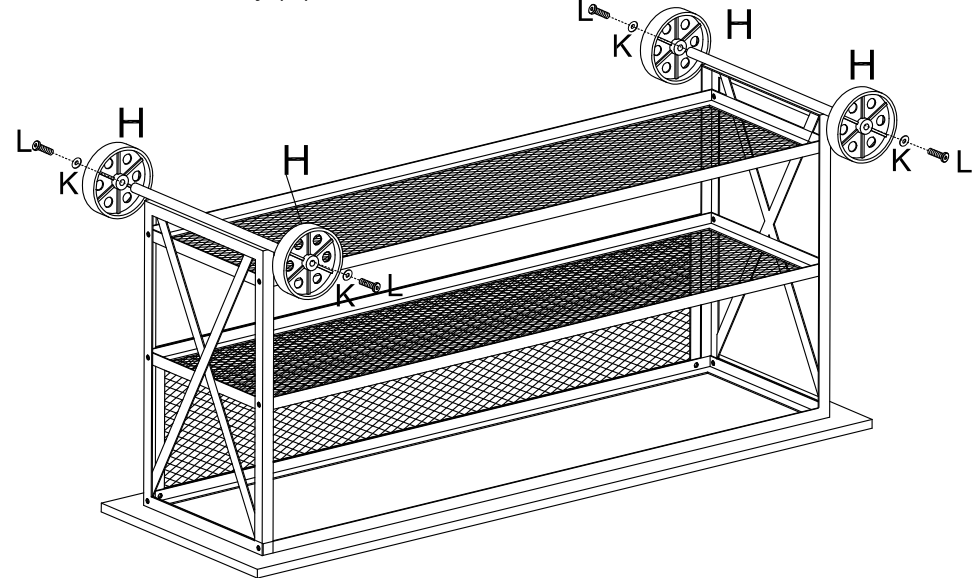

Step 3. Carefully bring the assembled cart to its upright position. Unpack and place Mesh Basket (G) onto the middle shelf as shown.

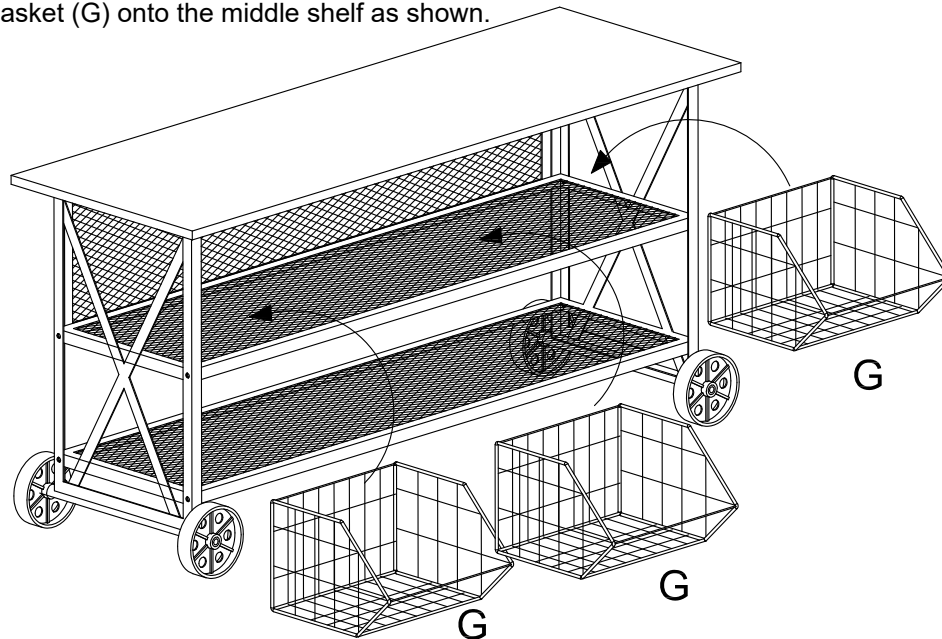

Step 4. The assembly is finished.

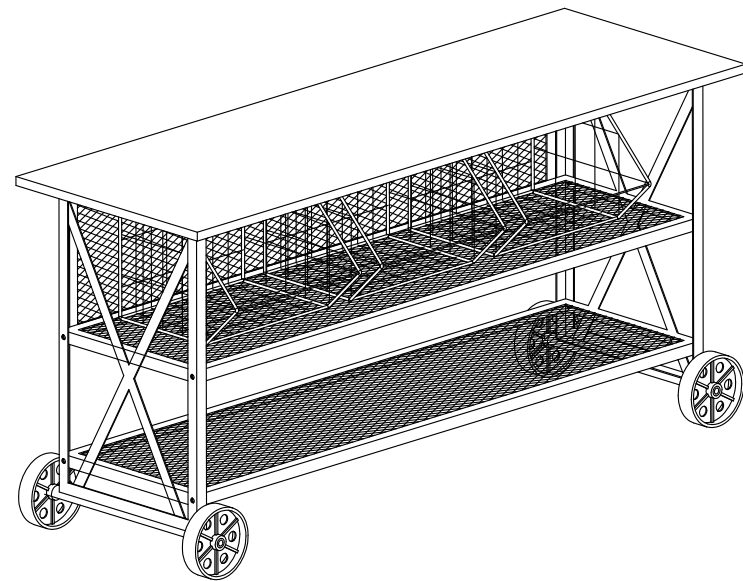

If you have any questions regarding our products, please visit us at www.displays2go.com or contact D2G customer service at 844-221-3388.